

RIGHT COPYRIGHT

For education

Copyright and Education in Europe:

**15 everyday cases
in 15 countries**

Infographics

March 2017

Copyright and Education in Europe: 15 everyday cases in 15 countries

Infographics
March 2017

Written by Teresa Nobre

Designed by André Rocha

Published by COMMUNIA International Association of the Digital Public Domain

Disclaimer: *This publication is not intended to be legal advice, and is not necessarily complete and accurate. Please consult a local lawyer if you need to know which educational uses are permitted by the copyright laws analysed in this publication. Educational uses permitted under extended collective licenses are not reflected in this publication.*

Public Domain

To the extent possible under law, all parties involved have waived all copyright and related or neighbouring rights to this publication. You can copy, modify, distribute, communicate and make the publication available to the public, even for commercial purposes, all without asking permission.

See:

<https://creativecommons.org/publicdomain/zero/1.0/>

This publication is also available online at:
<http://www.rightcopyright.eu>

COMMUNIA is a network of activists, researchers and practitioners from universities, NGOs, and SME established in 10 Member States. COMMUNIA advocates for policies that expand the public domain and increase access to and reuse of culture and knowledge. We seek to limit the scope of exclusive copyright to sensible proportions that do not place unnecessary restrictions on access and use.

I. Materials Available For Use in Education



Images

Student wants to quote entire artwork in a digital presentation

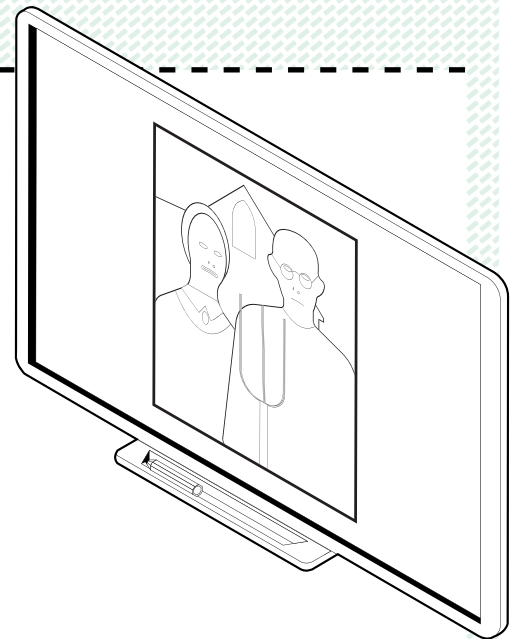

Is this legal?

In most countries it is possible to quote an entire work, since quotations can have whatever extent that is needed for the educational purpose. In others, however, one can only quote parts of works, which means that a student cannot present an entire image.

Copyright should allow quotations of works to the extent justified by the educational purpose!

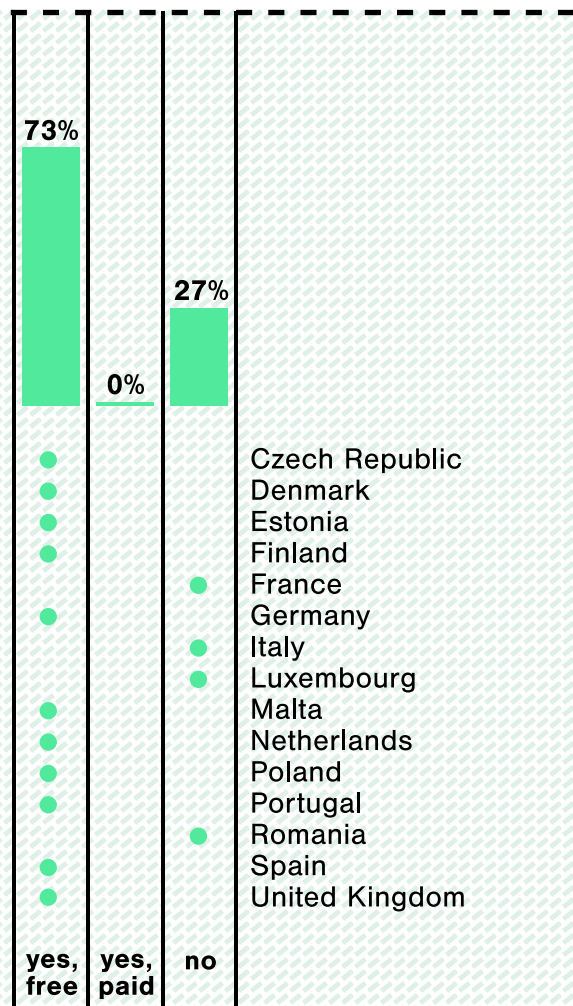

Textbooks

Teacher wants to scan pages from a textbook to show in class

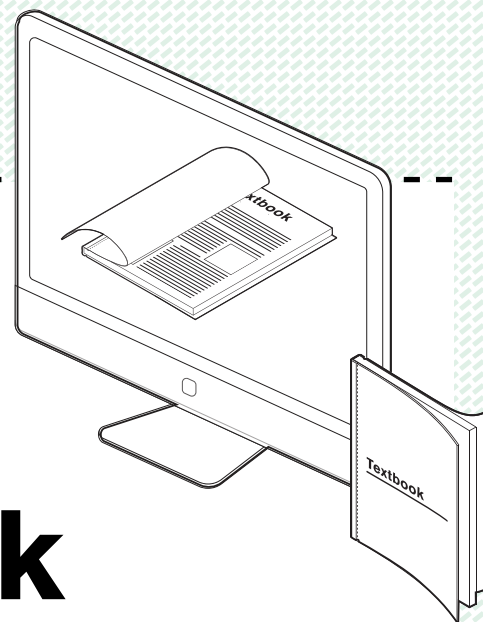

Is this legal?

In general, copyright laws do not restrict uses of textual works for educational purposes, except if those works are textbooks.

In some countries teachers need to ask permission and pay just to scan a few pages of a textbook or an academic book.

Copyright should allow uses of educational publications!

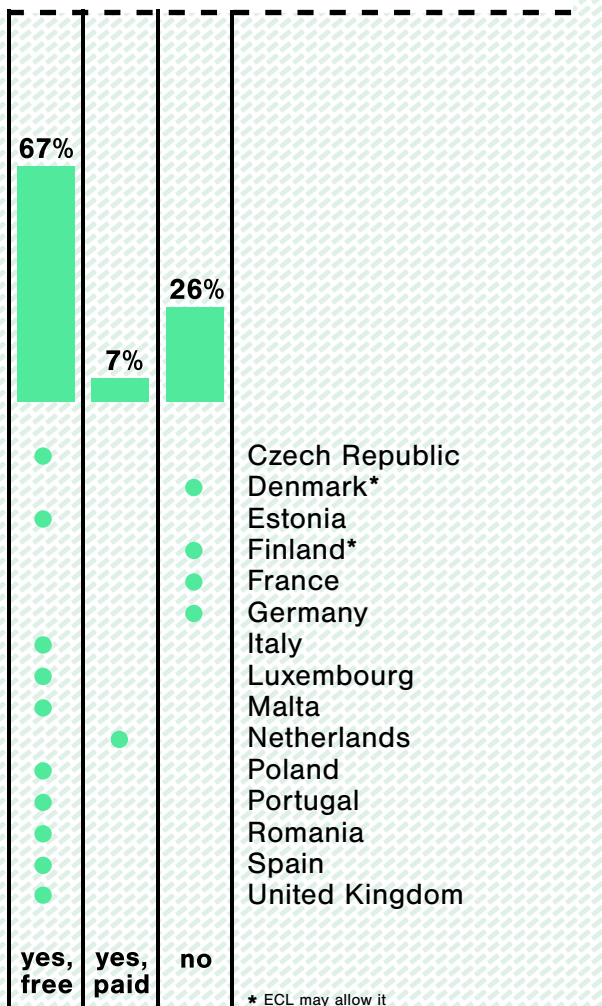

Audiovisuals

Teacher wants to record a TV programme to show in class

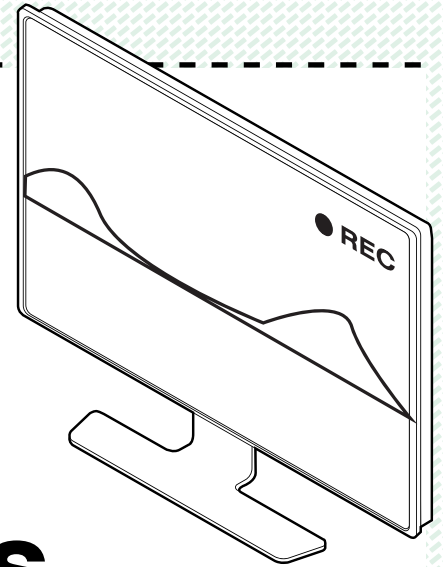

Is this legal?

Copying a TV programme for private use would not be a problem in most countries, but to show it in class would.

Video works are one of the least used types of works in education in the EU, largely because of copyright concerns.

Copyright should allow uses of all types of works!

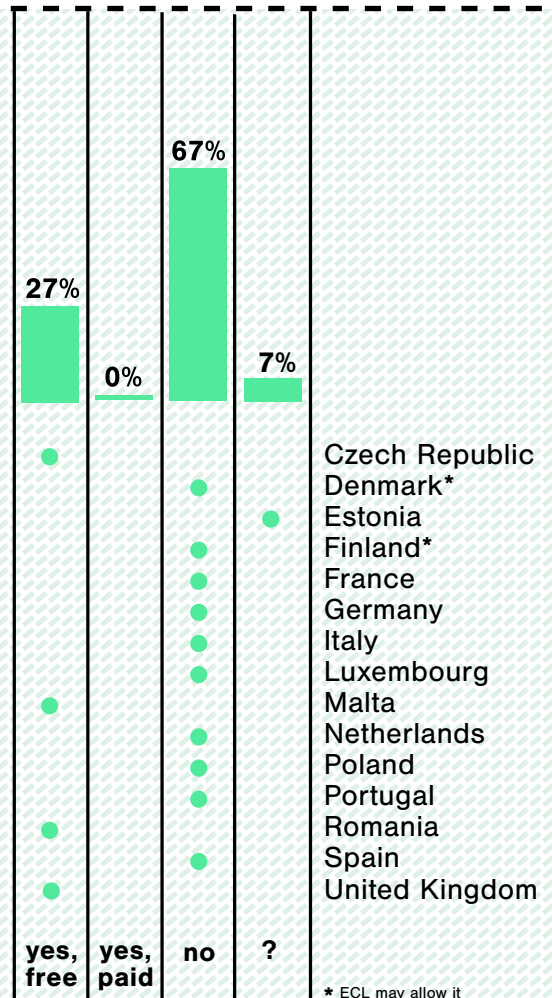

* ECL may allow it

II. Traditional Educational Practices

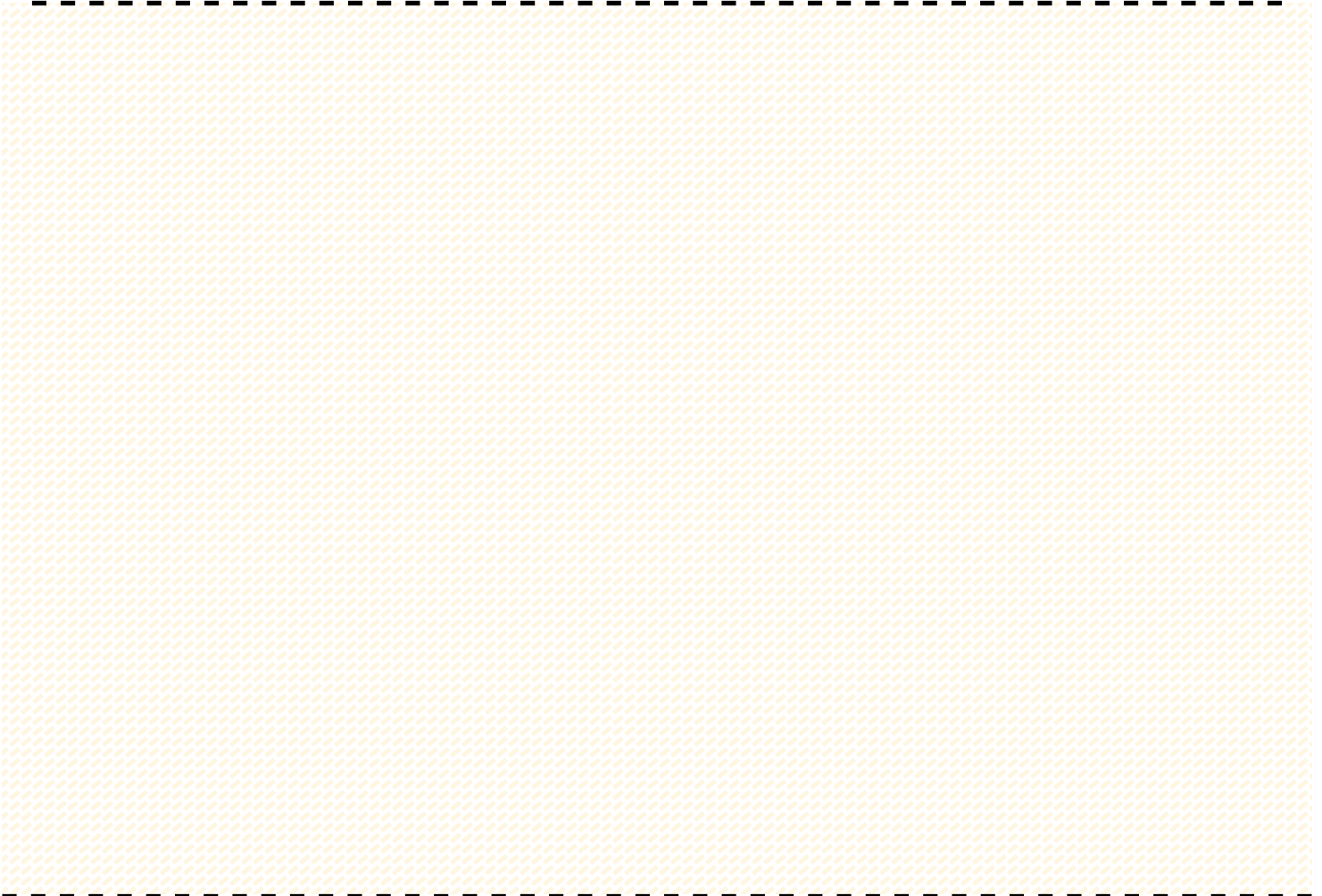

Playing

Teacher wants students to play a music piece in class

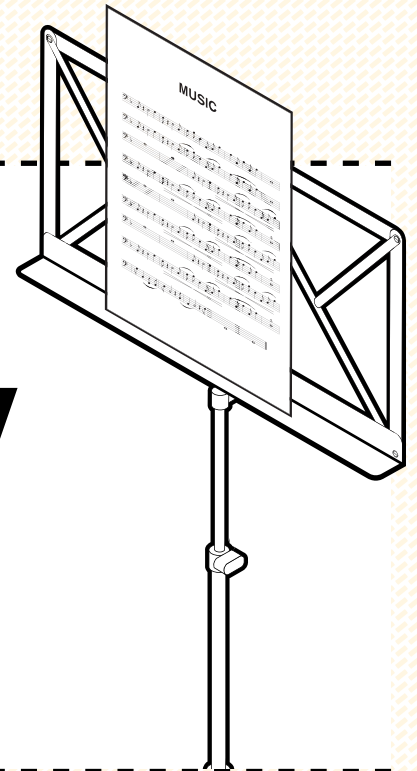

Is this legal?

Some laws only allow educational use of parts of works, thus preventing students from playing an entire music piece in class.

Other laws do not permit the very act of performing a work in class.

And, yet, others prohibit the use of printed musical scores in education.

Copyright should allow traditional educational practices!

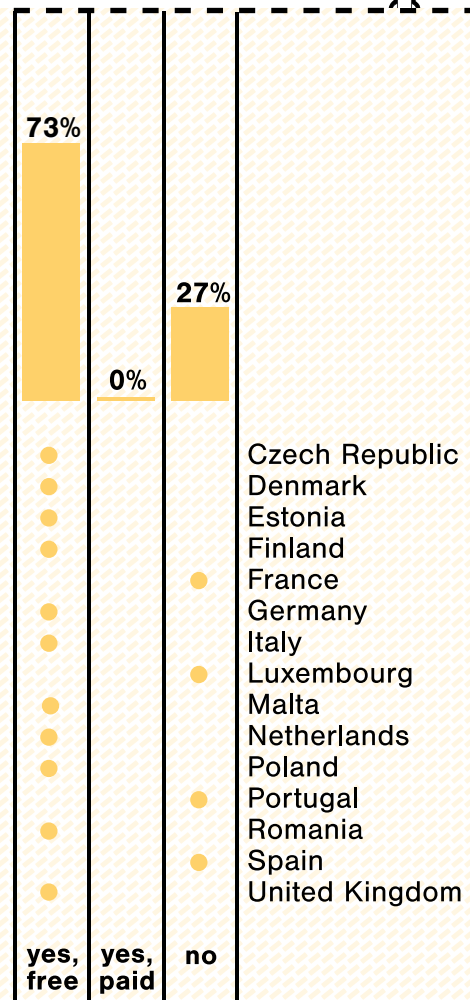

Performing Students want to perform a **theatrical** play in a **school event**

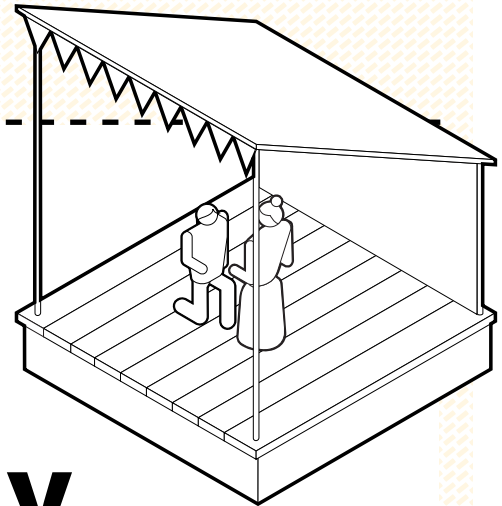

Is this legal?

In some countries, educators and learners have the freedom to play, recite or perform a work in school. In others, however, copyright laws would prohibit any public performance, even if it is done in a school event, for parents, with no commercial purposes.

Copyright should allow traditional school practices!

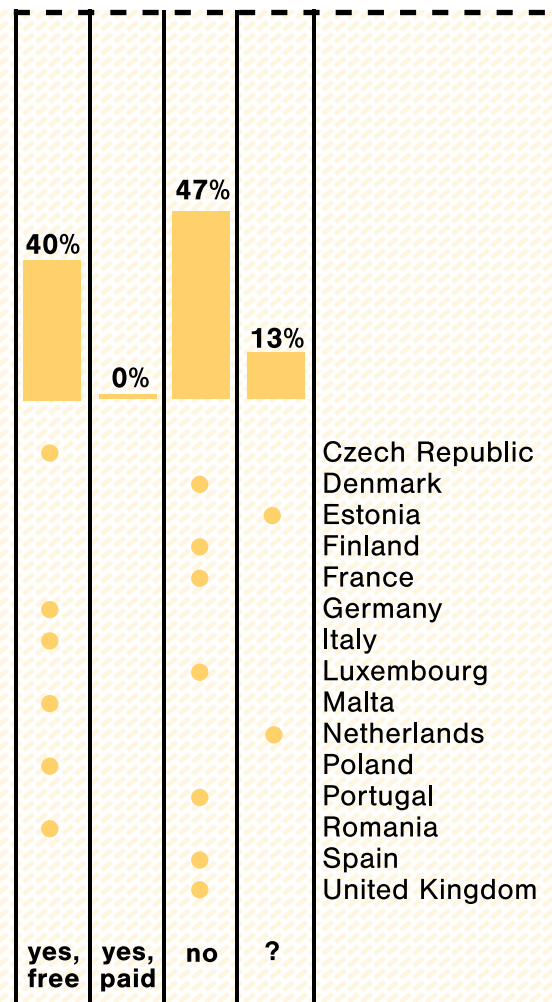

Screening

Teacher wants to screen and discuss a movie from a DVD in class

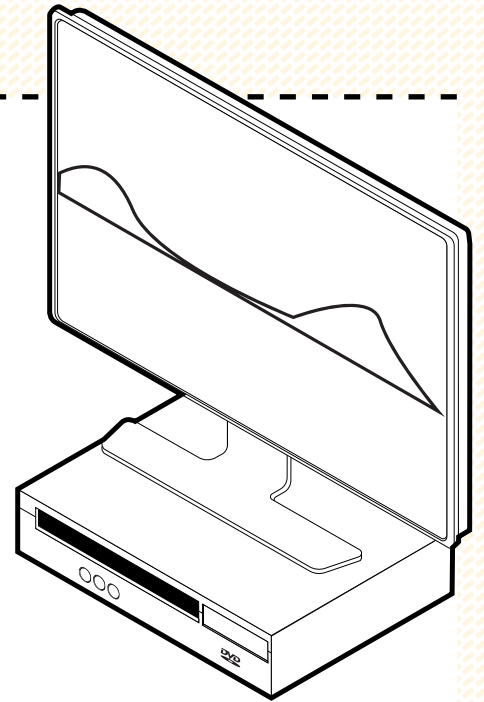

Is this legal?

Several countries consider that screening a film to an entire classroom is legal, because a group of students and teachers is different from a cinema audience. Other laws do not contain such distinction. In the Nordic countries, cinematographic works cannot be shown in the context of education.

Copyright should allow traditional viewing practices!

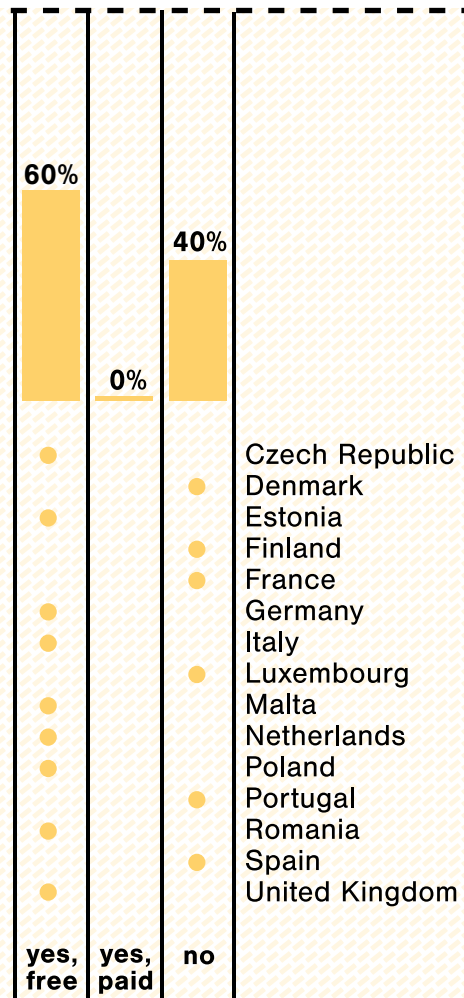

III. Modern Educational Practices

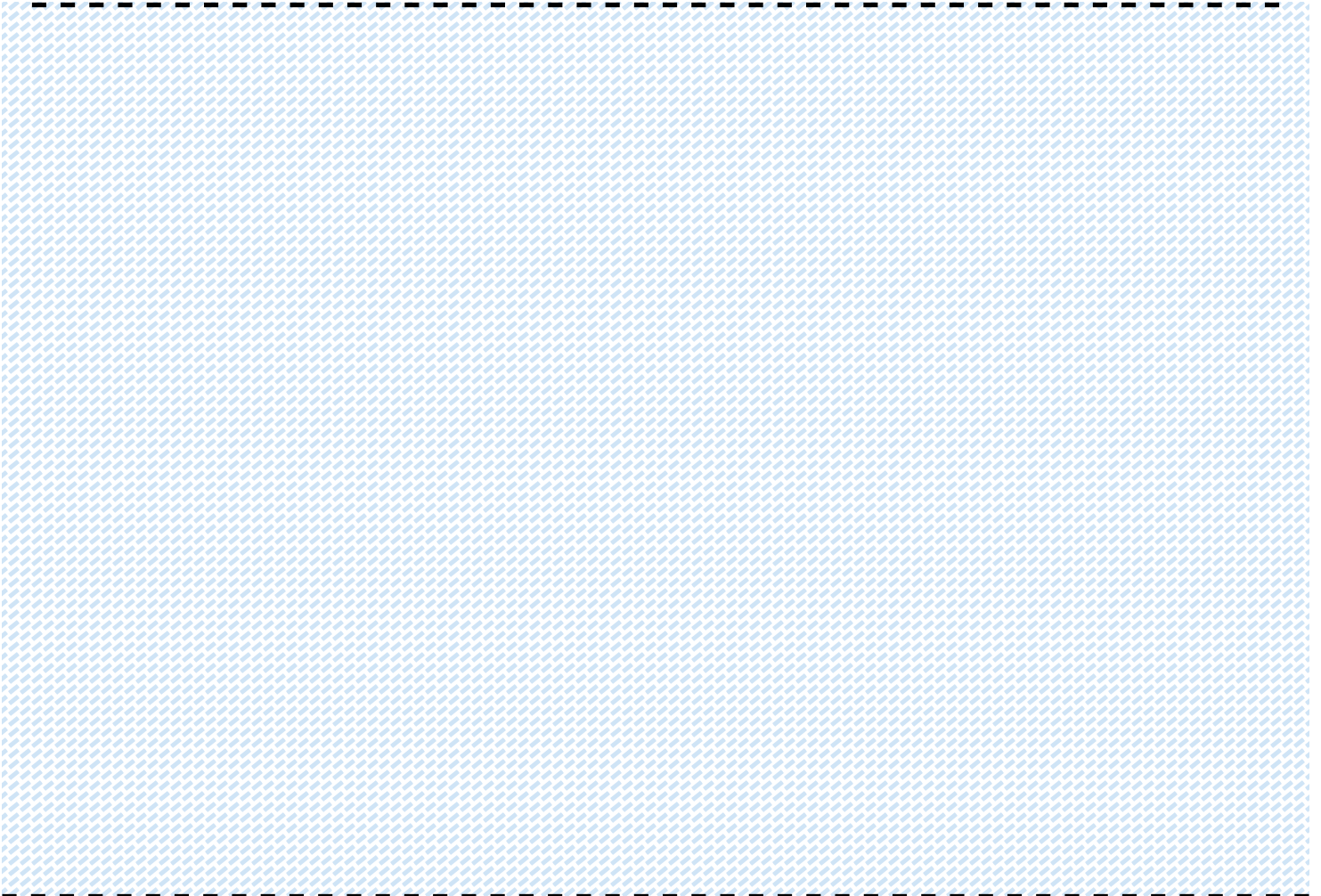

Showing

Teacher wants to show and discuss an **online video** in class

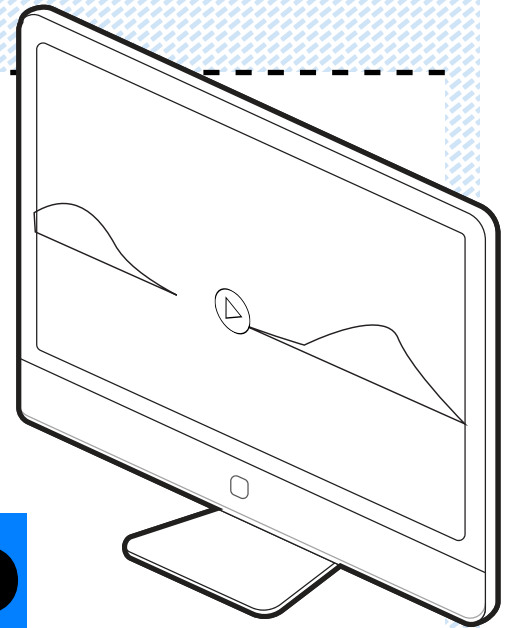

Is this legal?

Showing a publicly available online video to an entire classroom is prohibited under several copyright laws.

Viewing materials in class is one of the most relevant practices in today's education, yet, under those laws students can only view online materials in private.

Copyright should allow modern educational practices!

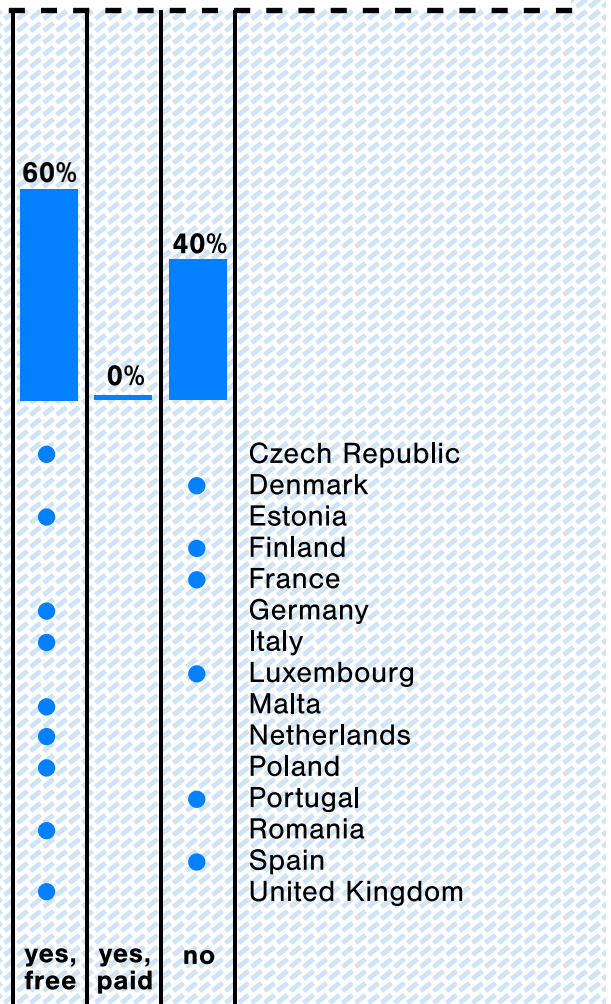

Emailing

Teacher wants to email reading materials to students

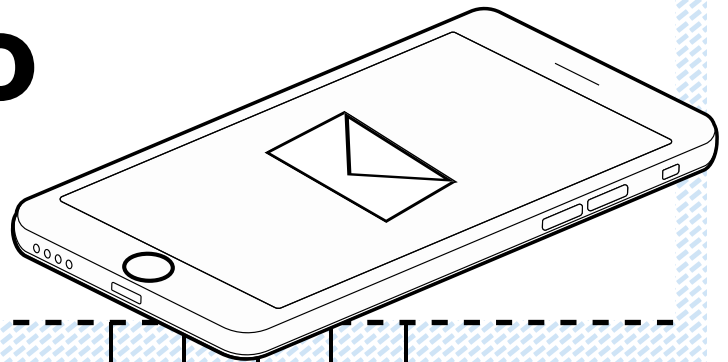

Is this legal?

Sending excerpts of works via email and other private tools is possible in several countries, but some laws would require the teacher to email one student at a time. In other countries, the situation is uncertain.

Copyright should allow modern educational practices!

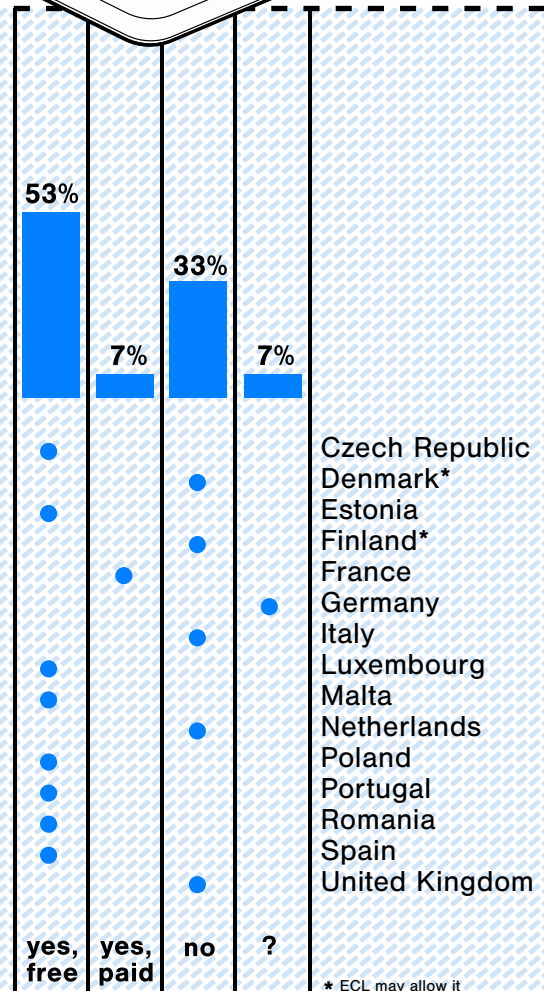

Posting

Teacher wants to share an **article** via the school's **closed network**

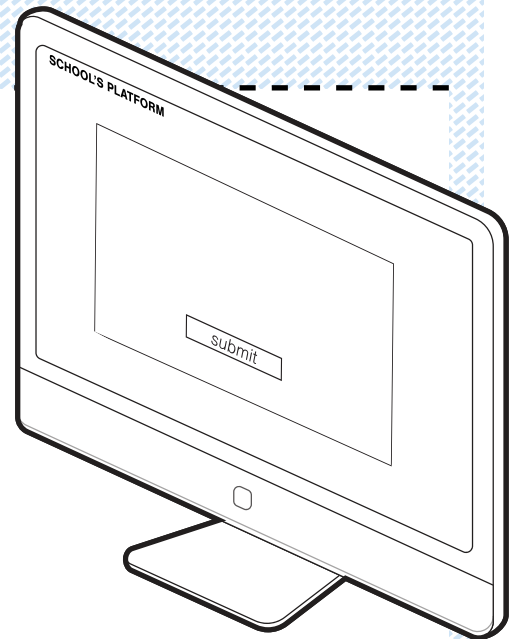

Is this legal?

In some countries posting a work on an institution's platform, accessible only by its students and teachers, is permitted.

In others, the use may be permitted but not for free. Finally, some laws only permit uses of parts of works, thus preventing the use of an entire short work, such as an individual article from a newsletter.

Copyright should allow the use of modern communication tools in education!

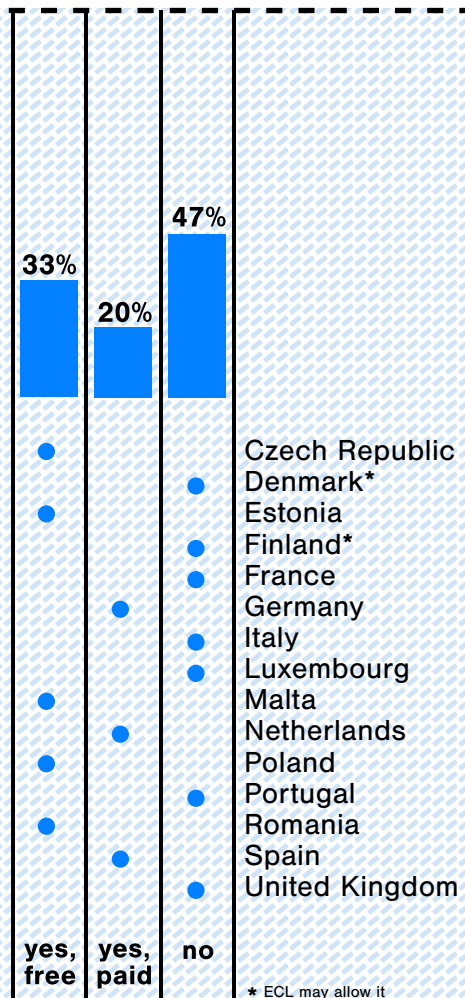

IV. Creation of Educational Materials



Quoting

Teacher wants to quote an **entire poem** in an educational resource

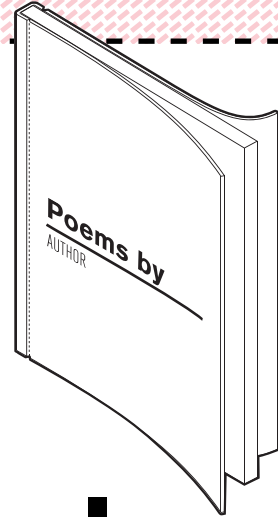

Is this legal?

In most countries it is possible to quote an entire poem, since quotations can have whatever extent that is needed for the educational purpose.

In others, however, one can only quote parts of works, which means that a teacher cannot insert an entire poem or an entire short work in a resource.

Copyright should allow quotations of works to the extent justified by the educational purpose!

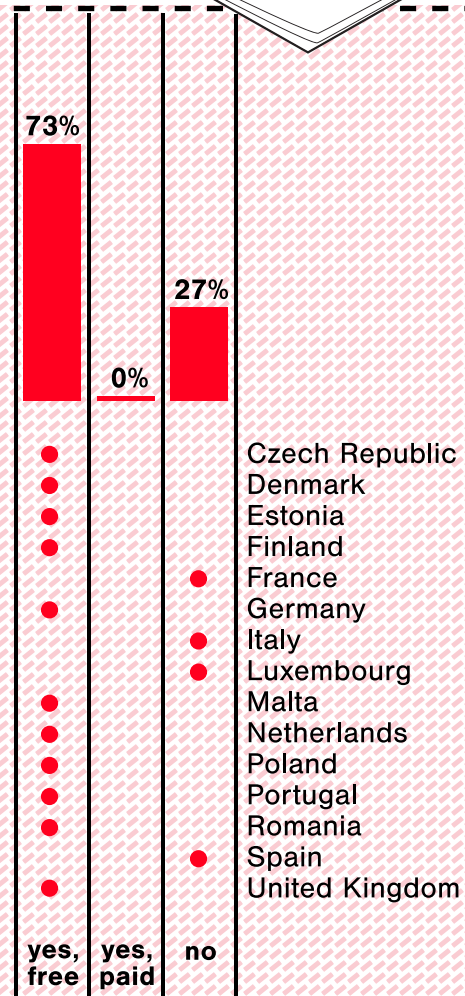

Compiling

Teacher wants to compile chapters from novels for use in class

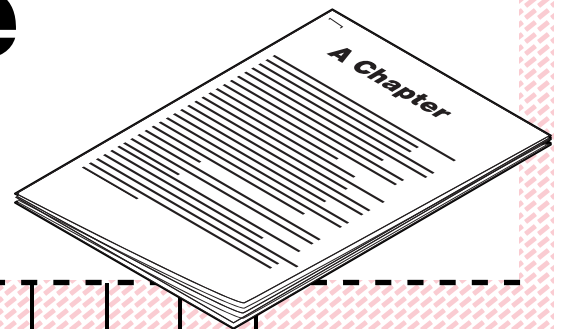
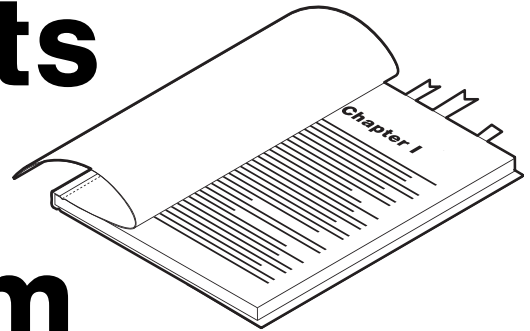

Is this legal?

Compiling materials is permitted in some countries and prohibited in others. Many laws do not differentiate between a set of materials created by a teacher and a publication intended for commercial use, and require payment of compensation in both cases.

Copyright should allow the creation of new educational works by compiling existing ones!

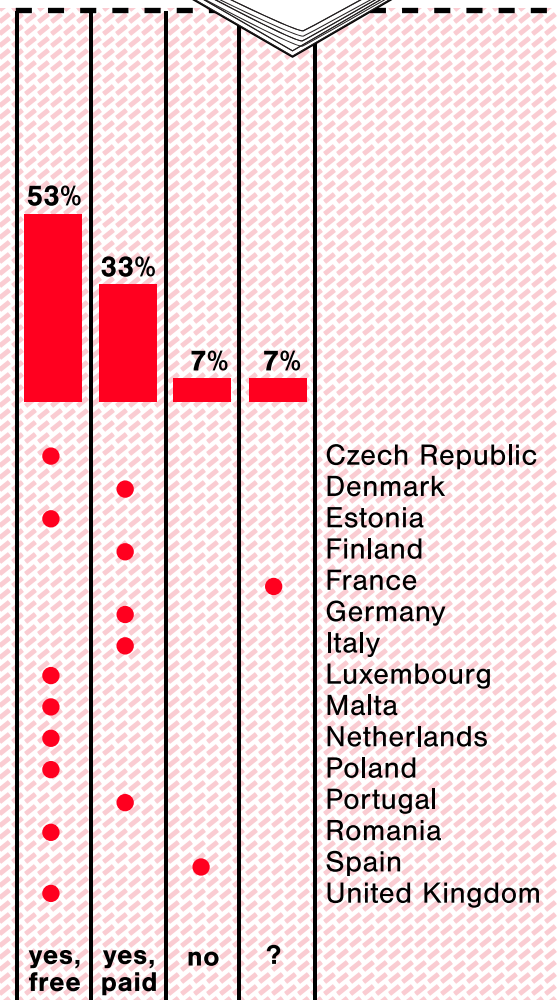

Translating

Teacher wants to translate **parts** of a **book** for use in class

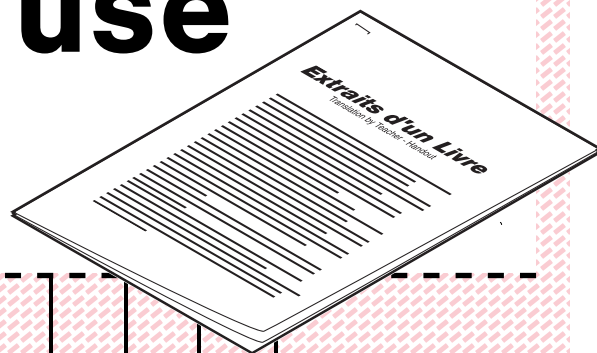
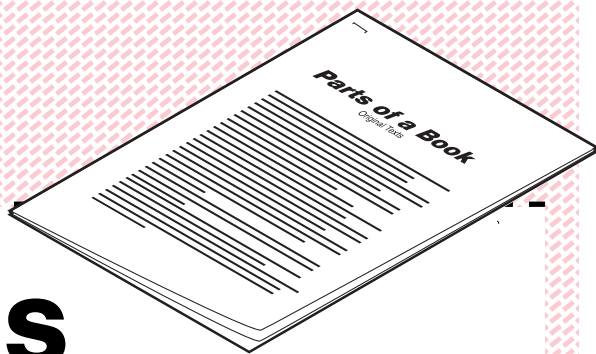

Is this legal?

Several countries exempt educational translations, as well as other adaptations of existing works to the local needs of educators and learners.

Others, however, do not foresee such uses, blocking creative reuses by educators.

Copyright should allow the creation of new educational works by translating existing ones!

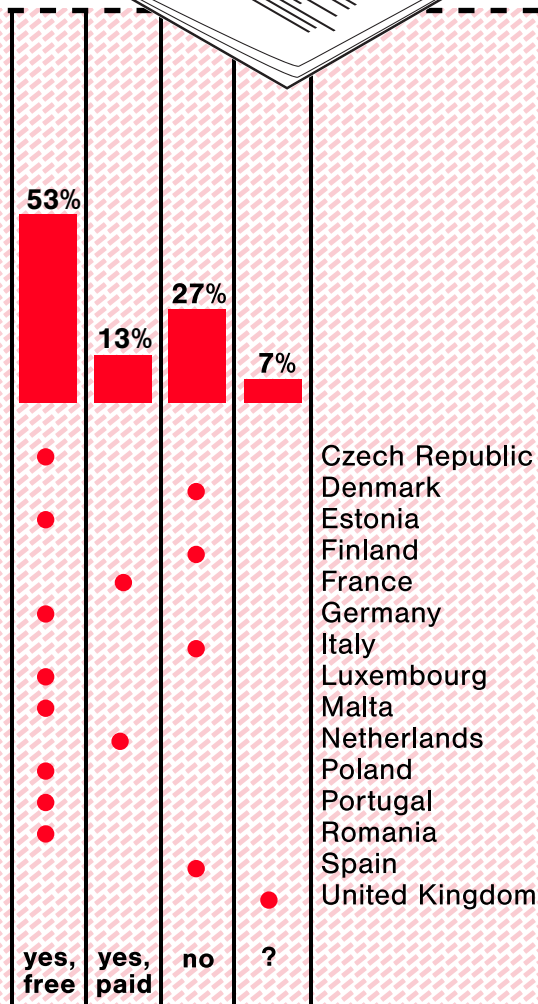

V. Non-Formal Education



Museums

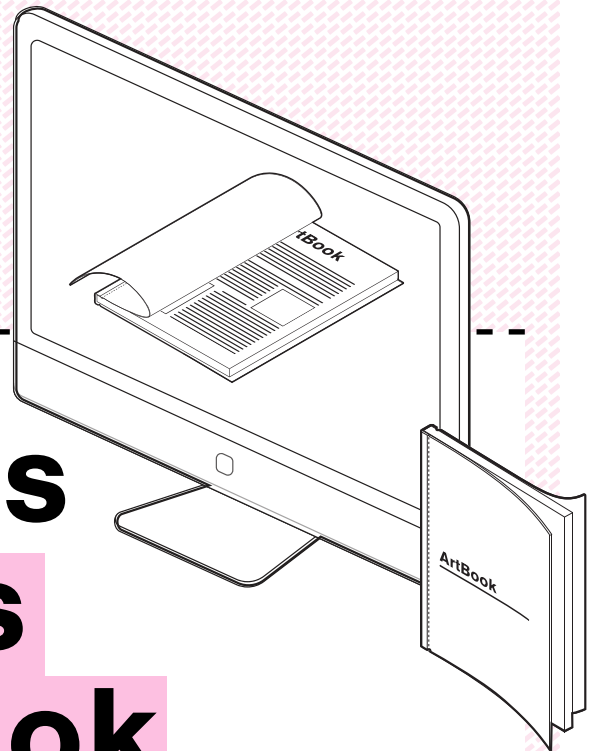

Museum wants to scan pages from an artbook to show to pupils

Is this legal?

While some copyright laws allow uses of protected works for any educational purposes, others only allow such uses if they are made by schools and other formal educational establishments. This means that museums and other providers of non-commercial education need to ask permission before using protected materials in their educational programmes.

Copyright should allow educational uses by museums!

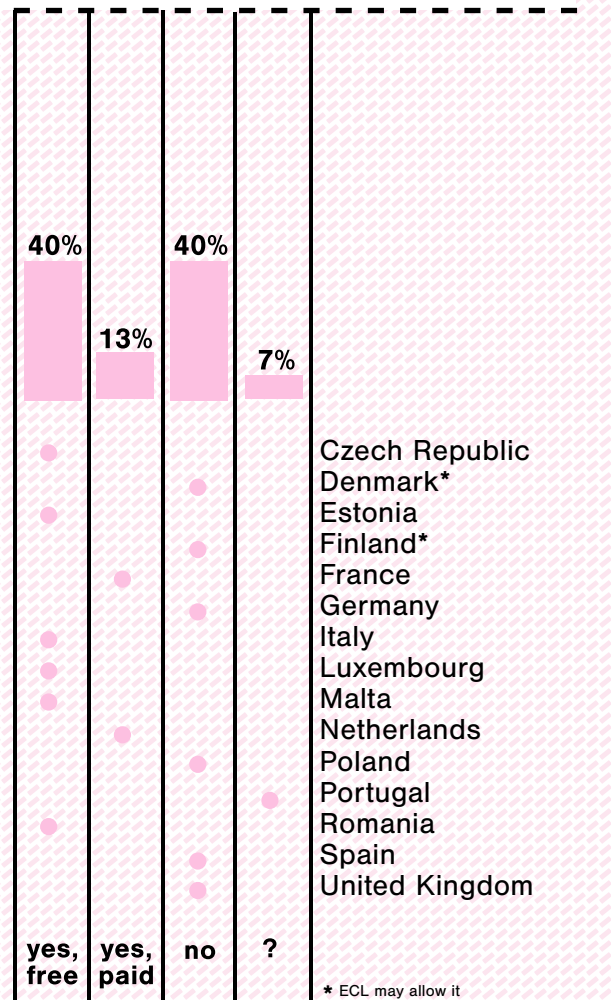

Libraries

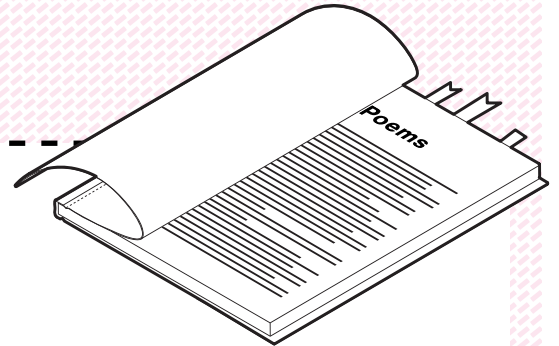

Library wants to compile poems to use in a free Poetry class



Is this legal?

Compiling materials is permitted in several countries, but some of those countries only exempt compilations made in the context of formal education. A library would, thus, be prevented from creating sets of copyrighted materials to use in its educational programmes.

Copyright should allow educational uses by libraries!

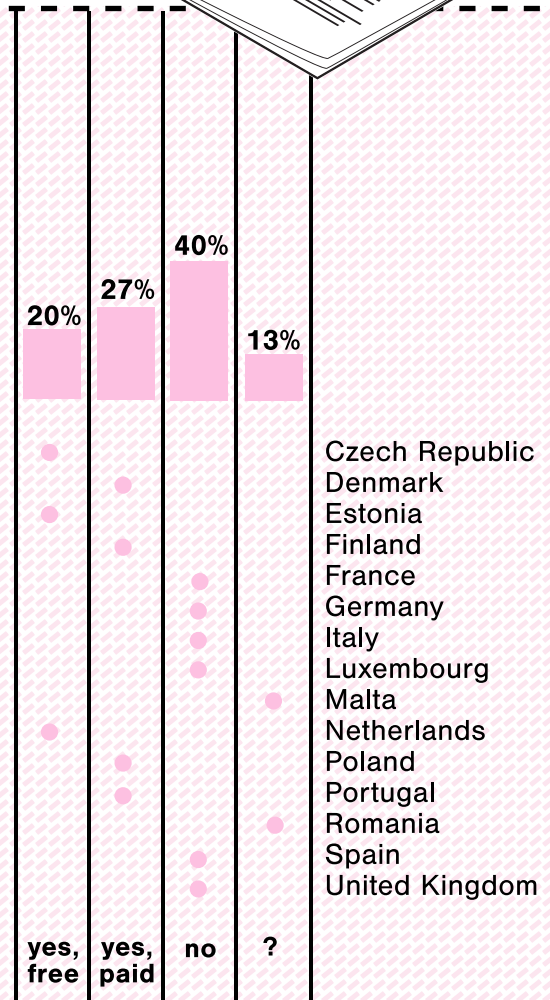

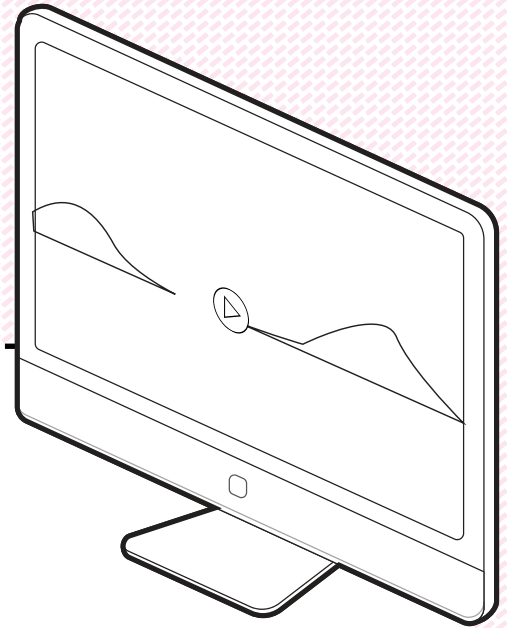

Nonprofit

NGO wants to show parts of a video in a free History class

Is this legal?

Several countries consider that showing a film to an entire classroom is legal, because a group of students and teachers is different from a cinema audience.

However, some of those countries only protect formal educational contexts, thus prohibiting similar educational uses by NGOs.

Copyright should allow educational uses by nonprofit organizations!

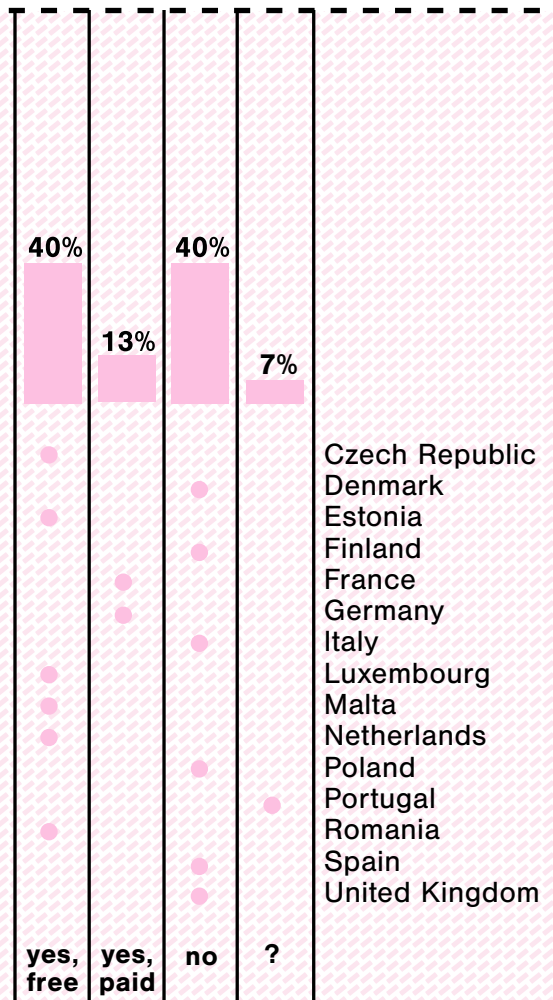

VI. Summary

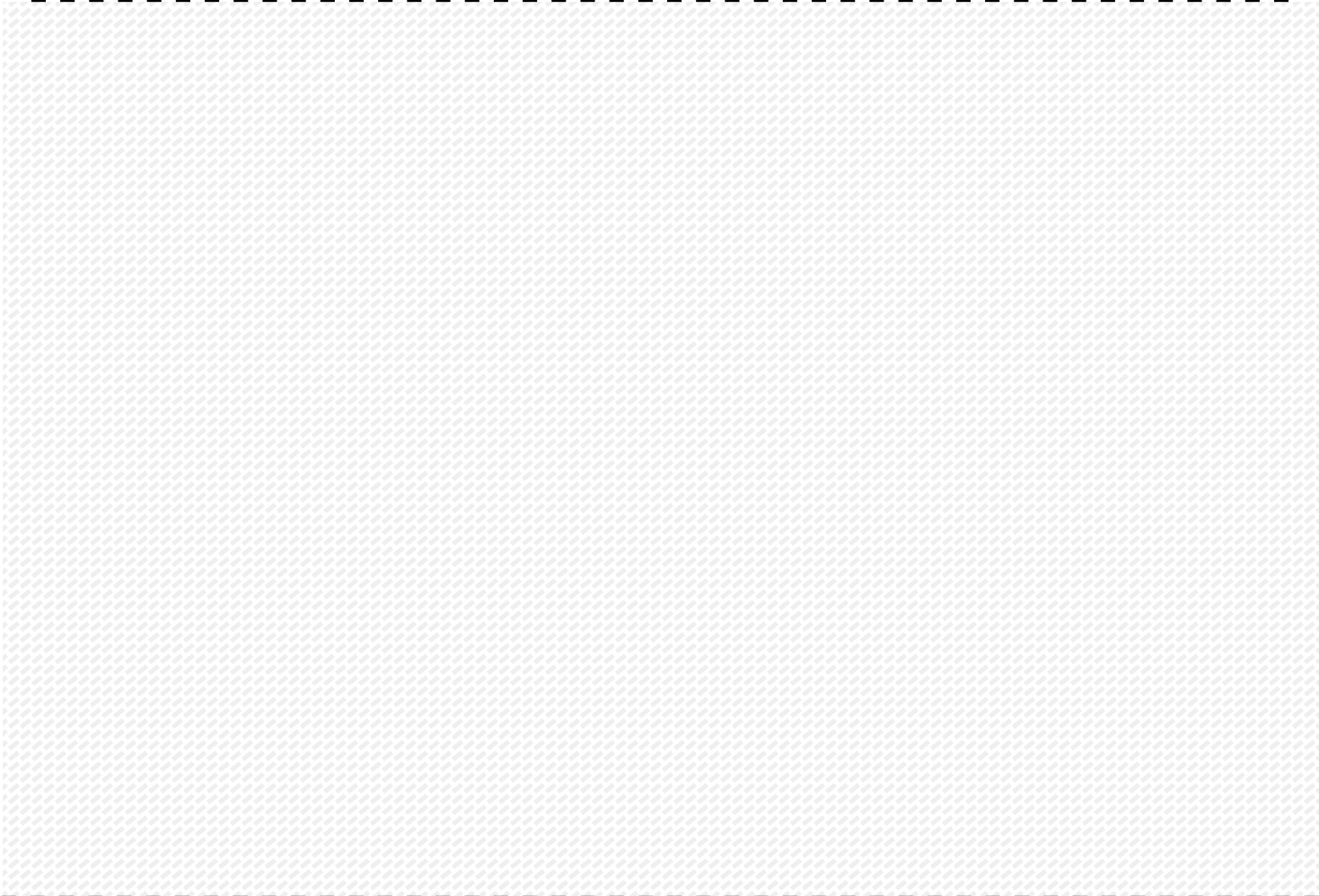

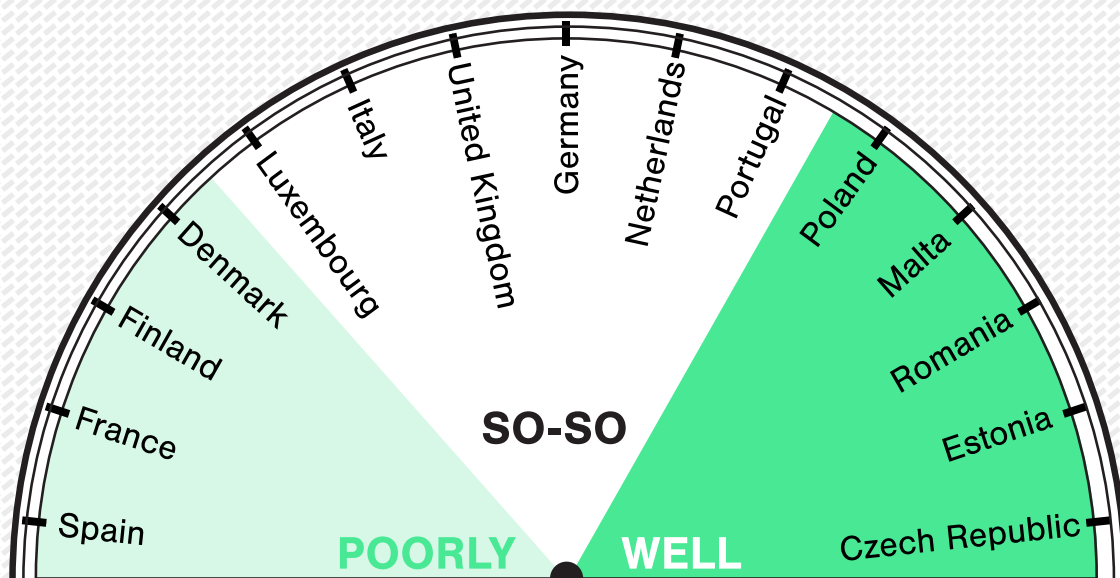

How 15 copyright laws treat education?

Educational Materials what can be used?

Entire Images

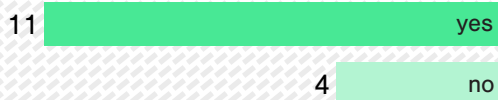

Textbooks

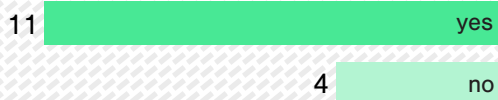

Entire Poem

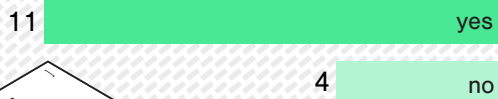

Educational Practices what can be done?

Compiling Materials

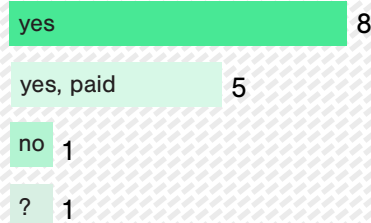

Performing Music Piece



Showing Online Video



Non-Formal Education

6 countries do not allow uses of protected materials in the context of non-formal education provided by museums, libraries and NGOs, without commercial purposes.

